



Make life full of hope

USER GUIDE

Solar inverter

IVCM PRO Series(1KW~3KW)

Solar inverter



Contents

ABOUT THIS MANUAL	1
Purpose.....	1
Scope	1
Safety instructions	1
WARNING MARKS	2
INTRODUCTION	3
Features	3
Basic system architecture	3
PRODUCT OVERVIEW	4
SPECIFICATIONS	5
INSTALLATION	7
Safety guidance	7
Unpacking and inspection	8
Preparation	8
Mounting the unit.....	8
Battery connection	9
AC input /output connection	10
PV connection	12
Final assembly	13
Dry contact signal	13
OPERATION	14
Power ON/OFF.....	14
Operation and display panel	14
LCD display icons	15
LCD operation flow chart	17
Base information Page	17
Setting Page	19
Rated information Page	22
Turbo mode	23
WARNING CODE TABLE	23
FAULT CODE TABLE	24

ABOUT THIS MANUAL

Purpose

This manual describes the assembly, installation, operation and troubleshooting of this unit. Please read this manual carefully before installations and operations. Keep this manual for future reference.

scope

This manual provides safety and installation guidelines as well as information on tools and wiring.





SAFETY INSTRUCTIONS

 **WARNING:** This chapter contains important safety and operating instructions. Read and keep this manual for future reference.

1. Before using the unit, read all instructions and cautionary markings on the unit, the batteries and all appropriate sections of this manual.
2. **CAUTION** --To reduce risk of injury, charge only deep-cycle lead acid type rechargeable batteries. Other types of batteries may burst, causing personal injury and damage.
3. Do not disassemble the unit. Take it to a qualified service center when service or repair is required. Incorrect re-assembly may result in a risk of electric shock or fire.
4. To reduce risk of electric shock, disconnect all wirings before attempting any maintenance or cleaning. Turning off the unit will not reduce this risk.
5. **CAUTION** – Only qualified personnel can install this device with battery.
6. **NEVER** charge a frozen battery.
7. For optimum operation of this inverter/charger, please follow required spec to select appropriate cable size. It's very important to correctly operate this inverter/charger.
8. Be very cautious when working with metal tools on or around batteries. A potential risk exists to drop a tool to spark or short circuit batteries or other electrical parts and could cause an explosion.
9. Please strictly follow installation procedure when you want to disconnect AC or DC terminals. Please refer to INSTALLATION section of this manual for the details.
10. Fuses (150A or 200A) are provided as over-current protection for the battery supply.
11. **GROUNDING INSTRUCTIONS** -This inverter/charger should be connected to a permanent grounded wiring system. Be sure to comply with local requirements and regulation to install this inverter.
12. **NEVER** cause AC output and DC input short circuited. Do NOT connect to the mains when DC input short circuits.
13. **Warning!!** Only qualified service persons are able to service this device. If errors still persist after following troubleshooting table, please send this inverter/charger back to local dealer or service center for maintenance.

WARNING MARKS

Warning marks inform users of conditions which can cause serious physical injury or death, or damage to the device. They also tell users how to prevent the dangers. The warning marks used in this operation manual are shown below:

Symbols	Name	Instruction
	Danger	Serious physical injury or even death may occur if not follow the relative requirements
	Warning	Physical injury or damage to the devices may occur if not follow the relative requirements
	Electrostatic sensitive	Damage may occur if not follow the relative requirements
	Hot surface	Sides of the device may become hot. Do not touch.
NOTE	Note	The procedures taken for ensuring proper operation.

INTRODUCTION

This is a multi-function inverter/charger, combining functions of inverter, MPPT solar charger and battery charger to offer uninterrupted power support with portable size. Its comprehensive LCD display offers user-configurable and easy-accessible button operation such as battery charging current, AC/solar charger priority, and acceptable input voltage based on different applications.

Features

- Pure sine wave inverter
- Built-in MPPT solar charge controller
- Configurable input voltage range for home appliances and personal computers via LCD setting
- Configurable battery charging current based on applications via LCD setting
- Configurable AC/Solar Charger priority via LCD setting
- Compatible to mains voltage or generator power
- Auto restart while AC is recovering
- Overload / Over temperature/ short circuit protection
- Cold start function
- Depending on the model, Turbo mode can be enabled in APL mode to use up to three times the maximum rated load

Basic System Architecture

The following illustration shows basic application for this inverter/charger. It also includes following devices to have a complete running system:

- Generator or Utility.
- PV modules (option)

Consult with your system integrator for other possible system architectures depending on your requirements.

This inverter can power all kinds of appliances in home or office environment, including motor-type appliances such as tube light, fan, refrigerator and air conditioner.

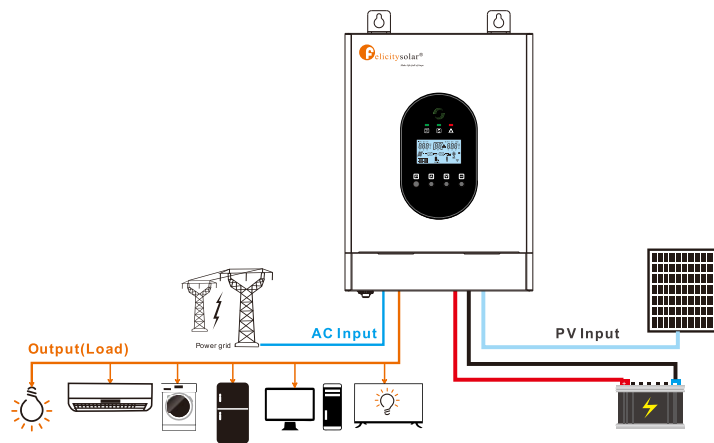

PRODUCT OVERVIEW

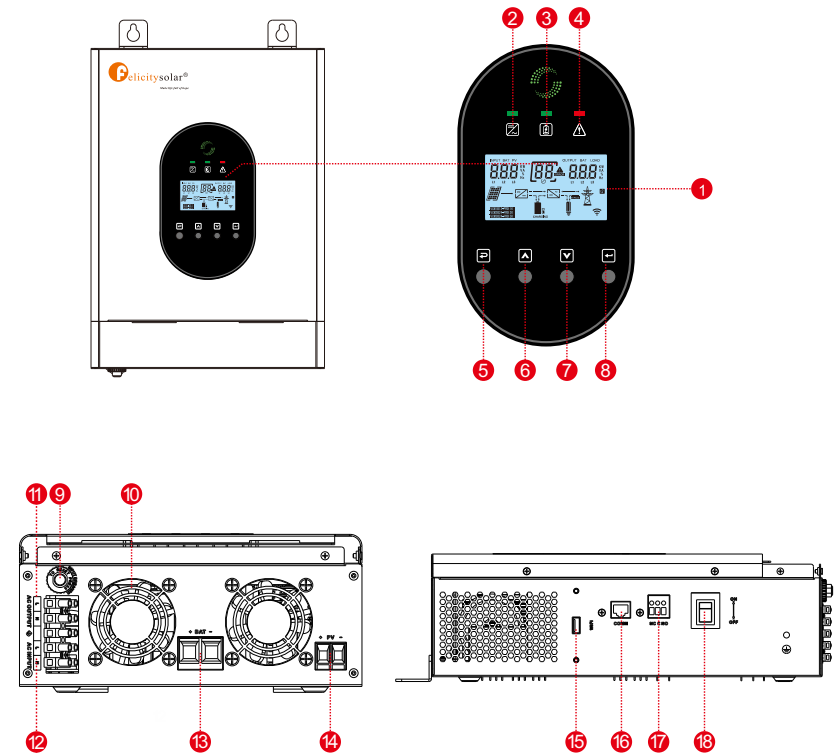

- | | | |
|----------------------------------|--------------------|------------------------------|
| 1. LCD display | 7. DOWN button | 13. Battery connection port |
| 2. Inverter or Utility indicator | 8. ENTER button | 14. PV input connection port |
| 3. Charging indicator | 9. Input breaker | 15. Wifi port |
| 4. Fault or warning indicator | 10. Fan | 16. RS485 communication port |
| 5. ESC button | 11. AC output port | 17. Dry node |
| 6. UP button | 12. AC input port | 18. Switch |

SPECIFICATIONS

Table 1 Line Mode Specifications

Line Mode Specifications			
Model	IVCM1012 PRO	IVCM2024 PRO	IVCM3024 PRO
Rated output Power	1000VA/1000W	2000VA/2000W	3000VA/3000W
Instant Output Power (Turbo Mode)	3000W	4000W	4500W
Nominal DC Input Voltage	12V	24V	24V
Input Voltage waveform	Sinusoidal (utility or generator)		
Nominal Input Voltage	230Vac		
Low Line voltage Disconnect	170Vac±7V(UPS); 90Vac±7V(Appliances)		
Low Loss Voltage Re-connect	180Vac±7V(UPS); 100Vac±7V(Appliances)		
High Line Voltage Disconnect	280Vac±7V		
High Line Voltage Re-connect	270Vac±7V		
Max AC Input Voltage	300Vac		
Nominal Input Frequency	50Hz/ 60Hz (Auto detection)		
Low Line Frequency Disconnect	40±1Hz		
Low Line Frequency Re-connect	42±1Hz		
High Line Frequency Disconnect	65±1Hz		
High Line Frequency Re-connect	63±1Hz		
Output Voltage Waveform	As same as input waveform		
Output Short Circuit Protection	Line mode: Circuit Breaker Battery mode: Electronic Circuits		
Efficiency (Line Mode)	>95% (Rated R load, battery full charged)		
Transfer Time (Single unit)	10ms typical (UPS); 20ms typical (Appliances)		
Max Bypass Overload Current	10A	15A	30A
Max Inverter/Rectifier Current	5A/1000W	10A/2000W	15A/3000W
Utility Charge Mode Specifications			
Nominal Input Voltage	230Vac		
Input Voltage Range	90-280Vac		
Nominal Output Voltage	Dependent on battery type		
Max Charge Current	20A		30A
Charge Current Regulation	10-20A (Adj 10A)		20-30A (Adj 10A)
Over Charge Protection	Yes		
Solar Charging & Grid Charging			
Max PV Open Circuit Voltage	105V	145V	
Operating Voltage Range	15-90V	30-120V	
Max Input Power	800W	1600W	
Max Solar Charging Current	60A		
Max Charging Current (PV + Grid)	80A		90A
Max Input Current	35A		

Charge Algorithm	
Algorithm	Three stage: Buck CC (Constant current stage) -> Buck CV (Constant voltage stage) -> Float (Constant voltage stage)







Charging curve			
Battery Type Setting	Battery Type	Buck CC/CV	Float
	AGM	14.4V/28.8V	13.6V/27.2V
	Flooded	14.6V/29.2V	13.8V/27.6V
	Self - defined	Adjustable, up to 15V/30V	
	Lithium		

Inverter Mode Specifications			
Model	IVCM1012 PRO	IVCM2024 PRO	IVCM3024 PRO
Rated output Power	1000VA/1000W	2000VA/2000W	3000VA/3000W
Instant Output Power (Turbo Mode)	3000W	4000W	4500W
Nominal DC Input Voltage	12V	24V	24V
Output Voltage Waveform	Pure sine wave		
Nominal Output Voltage	230Vac±5%		
Nominal output Frequency (Hz)	50±0.3Hz/60Hz±0.3Hz (Auto detection)		
Peak Efficiency	93%		
Over-Load Protection (SMPS load)	5s@≥150% load; 10s@110%~150% load		
Surge Rating			
Capable of Starting Electric	Yes		
output Short Circuit Protection	Yes		
Cold Start Voltage	11.5V	23.0V	
Low Battery Alarm			
@ Load < 20%	11.0V	22.0V	
@ 20% ≤ Load < 50%	10.7V	21.4V	
@ Load ≥ 50%	10.1V	20.2V	
Low Battery Alarm Recovery			
@ Load < 20%	11.5V	23.0V	
@ 20% ≤ Load < 50%	11.2V	22.4V	
@ Load ≥ 50%	10.6V	21.2V	
Low DC Input Shut-down			
@ Load < 20%	10.5V	21.0V	
@ 20% ≤ Load < 50%	10.2V	20.4V	
@ Load ≥ 50%	9.6V	19.2V	
High DC Input Alarm & Fault	15V	30V	
High DC Input Recovery	14.5V	29V	
General Specifications			
Operating Temperature	-10°C ~55°C		
Range Storage Temperature	-15°C ~60°C		
Net Weight (Kg)	5.5kg	6.5kg	6.5kg
Product Size (D*W*H)	340x248x107mm	340x248x107mm	340x290x124mm
Package Dimension (D*W*H)	422x330x181mm	422x330x181mm	422x372x198mm

INSTALLATION

Safety Guidance

Warning marks inform users of conditions which can cause serious physical injury or death, or damage to the device. They also tell users how to prevent the dangers. The warning marks used in this operation manual are shown below:

	<ul style="list-style-type: none"> After receiving this product, first confirm the product package is intact. If any question, contact the logistic company or local distributor immediately. The installation and operation of inverter must be carried out by professional technicians who have received professional trainings and thoroughly familiar with all the contents in this manual and the safety requirements of the electrical system. Do not carry out connection/disconnection, unpacking inspection and unit replacement operations on the inverter when power source is applied. Before wiring and inspection, users must confirm the breakers on DC and AC side of inverter are disconnected and wait for at least 5 minutes.
	<ul style="list-style-type: none"> Ensure there is no strong electromagnetic interference caused by other electronic or electrical devices around the installation site. Do not refit the inverter unless authorized. All the electrical installation must conform to local and national electrical standards
	<ul style="list-style-type: none"> Do not touch the housing of the inverter or the radiator to avoid scald as they may become hot during operation.
	<ul style="list-style-type: none"> Ground with proper technics before operation.
	<ul style="list-style-type: none"> Do not open the surface cover of the inverter unless authorized. The electronic components inside the inverter are electrostatic sensitive. Do take proper anti-electrostatic measures during authorized operation.
	<ul style="list-style-type: none"> The inverter needs to be reliably grounded.
	<ul style="list-style-type: none"> Ensure that DC and AC side circuit breakers have been disconnected and wait at least 5 minutes before wiring and checking.

INTRODUCTION

Unpacking and Inspection

Before installation, please inspect the unit. Be sure that nothing inside the package is damaged. You should have received the following items inside of package:

- The unit x 1
- User manual x 1

Preparation

Before connecting all wirings, please take off bottom cover by removing two screws as shown below.

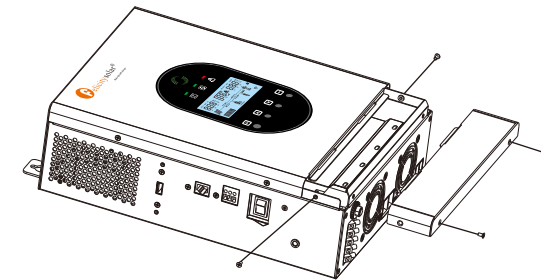

Mounting the Unit

Consider the following points before selecting where to install:

- Do not mount the inverter on flammable construction materials.
- Mount on a solid surface
- Install this inverter at eye level in order to allow the LCD display to be read at all times.
- The ambient temperature should be between -10°C and 55°C to ensure optimal operation.
- The recommended installation position is to be adhered to the wall vertically.
- Be sure to keep other objects and surfaces as shown in the right diagram to guarantee sufficient heat dissipation and to have enough space for removing wires.

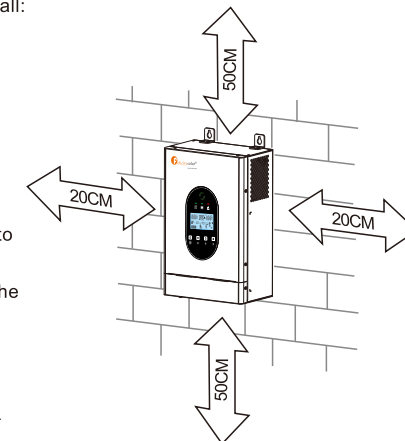

SUITABLE FOR MOUNTING ON CONCRETE OR OTHER NON-COMBUSTIBLE SURFACE ONLY.

Install the unit by screwing two screws.



Battery Connection

CAUTION: For safety operation and regulation compliance, it's requested to install a separate DC over-current protector or disconnect device between battery and inverter. It may not be requested to have a disconnect device in some applications, however, it's still requested to have over-current protection installed. Please refer to typical amperage in below table as required fuse or breaker size.

WARNING! All wiring must be performed by a qualified personnel.

WARNING! It's very important for system safety and efficient operation to use appropriate cable for battery connection. To reduce risk of injury, please use the proper recommended cable.

Recommended battery cable and terminal size:

Model	Typical Amperage	Battery Capacity	Wire Size	Torque Value
1KW/2KW	84A	100AH	1*4AWG	2~3Nm
		200AH	2*8AWG	
3KW	125A	100AH	1*4AWG	2~3Nm
		200AH	2*4AWG	

Please follow below steps to implement battery connection:

1. Assemble battery ring terminal based on recommended battery cable and terminal size.

2. The 1KW model supports only 12VDC systems. The battery string connection is the chart below. For 1KW models, you are advised to connect a battery with a capacity of at least 100Ah.

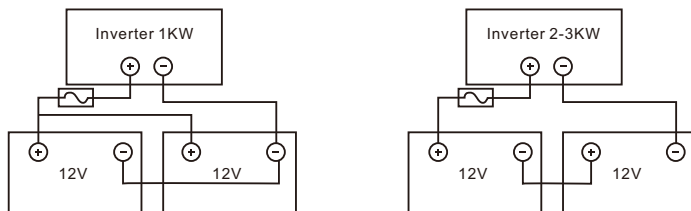

3. Insert of battery cable flatly into battery connector of inverter and make sure the bolts are tightened with torque of 2-3 Nm. Make sure polarity at both the battery and the inverter charge is correctly connected and are tightly screwed to the battery terminals.

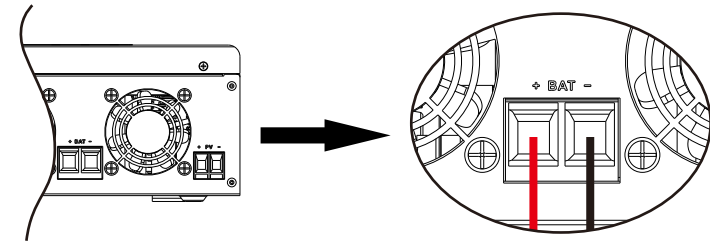

WARNING: Shock Hazard

Installation must be performed with care due to high battery voltage in series.



CAUTION!! Do not place anything between the flat part of the inverter terminal and the. Otherwise, overheating may occur.

CAUTION!! Do not apply anti-oxidant substance on the terminals before terminals are reconnected tightly.

CAUTION!! Before making the final DC connection or closing DC breaker/disconnector, be sure positive (+) must be connected to positive (+) and negative (-) must be connected to negative (-).

AC Input/Output Connection

CAUTION!! Before connecting to AC input power source, please install a separate AC breaker between inverter and AC input power source. This will ensure the inverter can be securely disconnected during maintenance and fully protected from over current of AC input. The recommended spec of AC breaker is 10A for 1KW.

CAUTION!! There are two terminal blocks with "IN" and "OUT" markings. Please do NOT mis-connect input and output connectors.

WARNING! All wiring must be performed by a qualified personnel.

WARNING! It's very important for system safety and efficient operation to use appropriate cable for AC input connection. To reduce risk of injury, please use the proper recommended cable size as below.

Suggested cable requirement for AC wires

Model	Gauge	Torque Value
1KW	16AWG	0.8 ~ 1.0 Nm
2KW	14AWG	0.8 ~ 1.0 Nm
3KW	12AWG	1.2 ~ 1.6 Nm

Please follow below steps to implement AC input/output connection:

1. Before making AC input/output connection, be sure to open DC protector or disconnector first.
2. Remove insulation sleeve 10mm for six conductors. And shorten phase L and neutral conductor N 3 mm.
3. Insert AC input wires according to polarities indicated on terminal block and tighten the terminal screws. Be sure to connect PE protective conductor (⊕) first.

- ⊕ → Ground (yellow-green)
- L → LINE (brown or black)
- N → Neutral (blue)

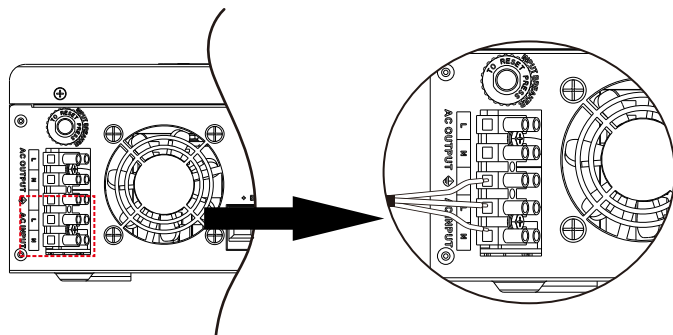

WARNING: Be sure that AC power source is disconnected before attempting to hardwire it to the unit.

4. Then, insert AC output wires according to polarities indicated on terminal block and tighten terminal screws. Be sure to connect PE protective conductor (⊕) first.

- ⊕ → Ground (yellow-green)
- L → LINE (brown or black)
- N → Neutral (blue)

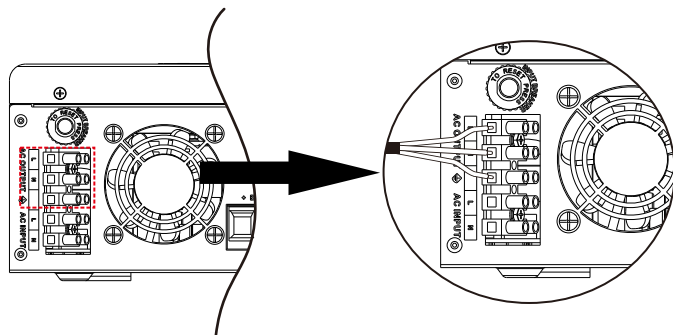

5. Make sure the wires are securely connected.

CAUTION : Important

Be sure to connect AC wires with correct polarity. If L and N wires are connected reversely, it may cause utility short-circuited when these inverters are worked in parallel operation.

CAUTION: Appliances such as air conditioner are required at least 2~3 minutes to restart because it's required to have enough time to balance refrigerant gas inside of circuits. If a power shortage occurs and recovers in a short time, it will cause damage to your least 2~3 connected appliances. To prevent this kind of damage, please check manufacturer of air conditioner if it's equipped with time-delay function before installation. Otherwise, this inverter charger will trigger overload fault and cut off output to protect your appliance but sometimes it still causes internal damage to the air conditioner.

PV Connection

CAUTION: Before connecting to PV modules, please install separately a DC circuit breaker between inverter and PV modules.

WARNING! All wiring must be performed by qualified personnel.

WARNING! It's very important for system safety and efficient operation to use appropriate cable for PV module connection. To reduce risk of injury, please use the proper recommended cable size as below.

Model	Typical Amperage	Cable Size	Torque
1KW / 2KW / 3KW	60A	8AWG	1.4~1.6 Nm

PV Module Selection:

When selecting proper PV modules, please be sure to consider below parameters:

1. Open circuit Voltage (Voc) of PV modules not exceeds max. PV array open circuit voltage of inverter.
2. Max. power voltage (Vmp) should be during PV array MPPT voltage range.

Solar Charging Mode		
INVERTER MODEL	1KW	2KW/3KW
Max. PV Array Open Circuit Voltage	105V	145V
PV Array MPPT Voltage Range	15Vdc~90Vdc	30Vdc~120Vdc

Please follow below steps to implement PV module connection:

1. Remove insulation sleeve 10 mm for positive and negative conductors.
2. Check correct polarity of connection cable from PV modules and PV input

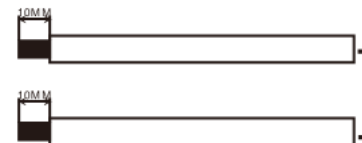

connectors. Then, connect positive pole(+) of connection cable to positive pole(+) of PV input connector. Connect negative pole (-) of connection cable to negative pole (-) of PV input connector.

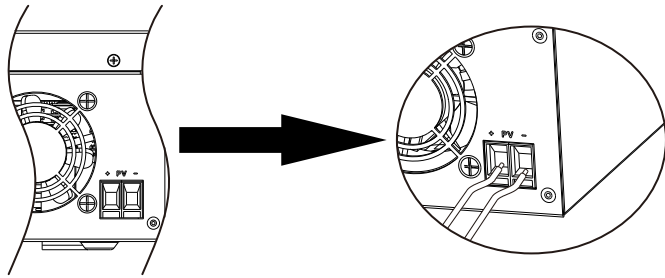

3. Make sure the wires are securely connected.

Final Assembly

After connecting all wirings, please put bottom cover back by screwing two screws as shown below.

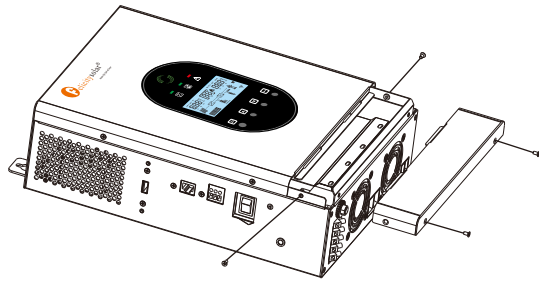

Dry Contact Signal

There is one dry contact (3A/250VAC) available on the rear panel. It could be used to deliver signal to external device when battery voltage reaches warning level.

Unit Status	Condition	Dry contact port: 	
		NC & C	NO & C
Power Off	Unit is off and no output is powered.	Close	Open
Power On	Battery voltage < Setting value in Program 12	NO & C	Close
	Battery voltage > Setting value in Program 13 or battery charging reaches floating stage	Close	NO & C

OPERATION

Power ON/OFF

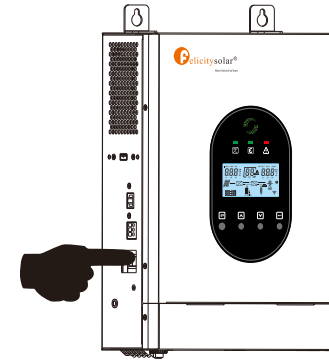





Once the unit has been properly installed and the batteries are connected well, simply press On/Off switch (located on the Left side of the case) to turn on the unit.

Operation and Display Panel

The operation and display panel, shown in below chart, is on the front panel of the inverter. It includes three indicators, four function keys and a LCD display, indicating the operating status and input/output power information.



Function Key	Icon	Description
ESC		To previous page
UP		To go to previous selection
DOWN		To go to next selection
ENTER		To confirm the selection or go to next page

LED Indicator	Icon	Description
Inverter		The inverter runs in off-grid mode, and the LED light will always be on. When the inverter is running in mains mode, the LED light will always flash. The inverter is not running in off-grid mode or mains mode, and the LED light is off.
Battery		Charging the battery, the LED flicker. battery is full, the LED light will always-on. The battery is not charged, the LED light will go out.
Fault		If inverter in fault event, the LED light will always-on. If inverter in warning event, the LED light will flash. Inverter work normally, the LED light will go out.
Buzzer Information		
Buzzer beep		Turn on/off the inverter, the buzzer will last for 2.5s. Press any button, the buzzer will last for 0.1s. Hold on the "ENTER" button, the buzzer will last for 3s. If in fault event, the buzzer will keep going. If in warning event, the buzzer will beep discontinuous (Check more information on the chapter of "Warning Code Table").

LCD Display Icons

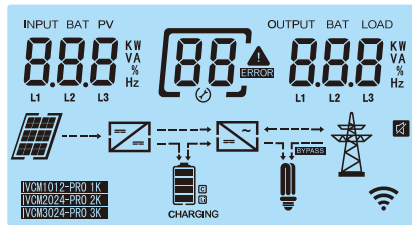

Icon	Function description
Input Source Information	
	Indicate input voltage, input frequency, PV voltage, PV power, battery voltage and charger current.
Configuration Program and Fault Information	
	Indicates the setting programs.
	Indicates the warning and fault codes. Warning: flashing with warning code. Fault: lighting with fault code

output Information	
	Indicate output voltage, output frequency, load percent, load in VA, load in Watt and discharging current.
Battery Information	
	Indicates battery level by 0-24%, 25-49%, 50-74% and 75-100%.
	Indicates Lithium battery type.
	Indicates communication is built between inverter and battery.
Mode operation Information	
	Indicates the utility.
	Indicates load is supplied by utility directly.
	Indicates that the load has an output.
	Indicates the inverter/charger is working.
	Indicates the PV panels.
	Indicates PV MPPT is working.
	Indicates the WIFI link.
	Indicates machine model.
Mute Operation	
	Indicates unit alarm is disabled.

LCD operation flow chart

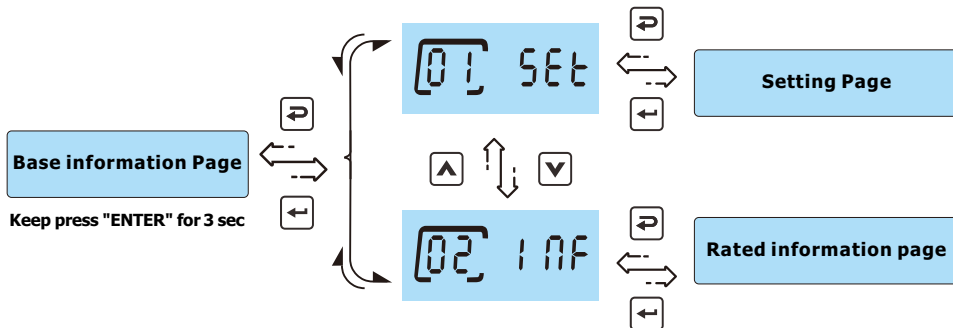

On base information page, pressing and holding "ENTER" key for 3 sec, the unit will enter parameters page. Press "UP" or "DOWN" key to switch the selection and press "ENTER" key to enter selected page. Press "ESC" key to back to previous page.

Base information Page

The base information will be switched by pressing "UP" or "DOWN" key. The selectable information is switched as below order:

<p>Input voltage / output voltage Utility voltage is 230v, output voltage is 230V</p>	<p>Input frequency / output voltage Utility frequency is 50.0Hz, output voltage is 230V</p>
<p>PV voltage / Output voltage PV voltage is 80V, output voltage is 230V</p>	<p>PV power / Output voltage PV power is 800W, output voltage is 230V</p>

<p>Battery voltage / Output voltage Battery voltage is 13.0v, output voltage is 230V</p>	<p>Charging current / Output voltage Charging current is 60A, output voltage is 230V</p>
<p>Battery voltage / Output frequency Battery voltage is 13.0v, output frequency is 50.0Hz</p>	<p>Battery voltage / Load percentage Battery voltage is 13.0V, load percentage is 40%</p>
<p>Battery voltage / Load VA Battery voltage is 13.0V, output wattage is 1.00kVA</p>	<p>Battery voltage / Load wattage Battery voltage is 13.0v, output wattage is 1.00kW</p>
<p>Battery voltage / Discharging current Battery voltage is 13.0V, discharging current is 77A</p>	

Setting Page

Press "UP" or "DOWN" button to select setting programs. And then, press "ENTER" button to confirm the selection or ESC button to exit.

Setting items:

		Selectable option	
00	Exit setting		
01	Output voltage setting	220V 	Output voltage configuration
		230V 	
		240V 	
02	Output frequency setting	50Hz 	Output frequency configuration
		60Hz 	
03	Utility input range setting	Appliance mode 	APL should be selected, when the utility is not well.
		UPSmode 	
04	Output source priority	Utility >> PV >> Battery 	Utility provides power to the loads first. PV and battery will provide power to loads only when utility is not available.
		PV >> Utility >> Battery 	PV provides power to the loads first. If PV is not sufficient, utility will supply power the loads at the same time. Battery will provide power to loads only when utility is not available.
		PV >> Battery >> Utility 	PV provides power to the loads first. If PV is not sufficient, battery will supply power to the loads at the same time. Utility provides power to the loads only when battery voltage drops to the setting point in program 12.

05	Charger priority	If inverter is working in utility mode, charger priority can be set as below. However, when inverter is working in Battery mode, only PV can charge battery.	
		PV first 	PV will charge battery first. Utility will charge battery only when PV is unavailable.
		PV and Utility 	PV and utility will charge battery together.
06	Max charging current (Utility charge current + PV charging current)	1KW-2KW model 	Setting range is from 10A to 80A. Increment of each click is 1A.
		3KW model 	Setting range is from 10A to 90A. Increment of each click is 1A.
07	Max utility charging current setting	1KW-2KW model 	Setting range is from 10A to 20A. Increment of each click is 10A.
		3KW model 	Setting range is from 20A to 30A. Increment of each click is 10A.
08	Battery type setting	The battery type is AGM 	If "Self-defined" or "Lib" is selected, battery charge voltage and low DC cut-off voltage can be set up in program 9, 10 and 11. If "Lib" is selected, inverter can charge Lithium battery when the Lithium battery need to be activated. Please make sure Lithium battery is connected before you start up inverter. If inverter doesn't connect battery or Lithium battery, do not select "Lib" battery type.
		The battery type is Flooded 	
		The battery type is self-defined 	
		The battery type is Lib 	

09	Bulk charging voltage setting (C.V voltage)	12V model [4] [09] 14.1 ^v	If "self-defined" or "Lib" is selected in program 8, this program is enabled. Setting range is from 12.0V to 15.0V. Increment of each click is 0.1V
		24V model [4] [09] 28.2 ^v	If "self-defined" or "Lib" is selected in program 8, this program is enabled. Setting range is from 24.0V to 30.0V. Increment of each click is 0.1V
10	Floating charging voltage	12V model FL4 [10] 13.5 ^v	If "self-defined" or "Lib" is selected in program 8, this program is enabled. Setting range is from 12.0V to 15.0V. Increment of each click is 0.1V
		24V model FL4 [10] 27.0 ^v	If "self-defined" or "Lib" is selected in program 8, this program is enabled. Setting range is from 24.0V to 30.0V. Increment of each click is 0.1V
11	Low DC cut-off voltage	12V bC4 [11] 11.5 ^v	If "self-defined" or "Lib" is selected in program 8, this program is enabled. Setting range is from 10.5v to 13.5V. Increment of each click is 0.1V
		24V bC4 [11] 23.0 ^v	If "self-defined" or "Lib" is selected in program 8, this program is enabled. Setting range is from 21.0v to 17.0V. Increment of each click is 0.1V
12	Setting battery voltage point back to utility when selecting "SBU priority" in program 4	12V bU4 [12] 11.5 ^v	Setting range is from 11.0V to 13.5V. Increment of each click is 0.1V
		24V bU4 [12] 23.0 ^v	Setting range is from 22.0V to 17.0V. Increment of each click is 0.1V
13	Setting battery voltage point back to battery mode when selecting "SBU priority" in program 4	12V bB4 [13] 13.5 ^v	Setting range is from 12.0V to 15.0V. Increment of each click is 0.1V
		24V bB4 [13] 27.0 ^v	Setting range is from 24.0V to 30.0V. Increment of each click is 0.1V
		Fully charged bB4 [13] FUL	Battery should be charged to float charging stage.
14	Overload bypass function	Disable LbP [14] d15	If it is enabled, the inverter will switch to utility mode if overload happens in battery mode.
		Enable LbP [14] ENA	

15	Overload restart function	Disable OLr [15] d15	If it is enabled, the inverter will auto restart when overload occurs.
		Enable OLr [15] ENA	
16	Over temperature restart function	Disable Otr [16] d15	If it is enabled, the inverter will auto restart when over temperature occurs.
		Enable Otr [16] ENA	
17	Backlight of LCD	Disable bL [17] d15	If selected, LCD backlight will be off after no button is pressed for 60s.
		Enable bL [17] ENA	If selected, LCD backlight will be always-on.
18	Auto return to the first page of display screen	Disable bFP [18] d15	If selected, the display screen will stay at latest screen user finally switches.
		Enable bFP [18] ENA	If selected, it will automatically return to the first page of display screen (Input voltage/ output voltage) after no button is pressed for 60s.
19	Buzzer Alarm	Disable bEP [19] d15	If selected, buzzer is not allowed to beep.
		Enable bEP [19] ENA	If selected, buzzer is allowed to beep.
20	Turbo Mode	Disable tTb [20] d15	If selected, inverter cannot overload derated output.
		Enable tTb [20] ENA	If selected, inverter starts the overload derated output. Max 3KVA load.

Rated information Page

The rated information will be switched by pressing "UP" or "DOWN" key. The selectable information is switched as below order:

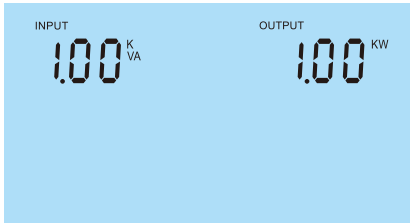
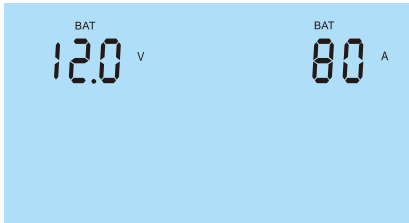
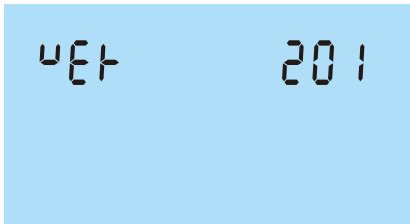
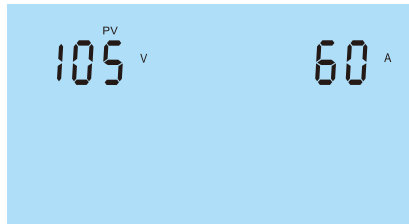
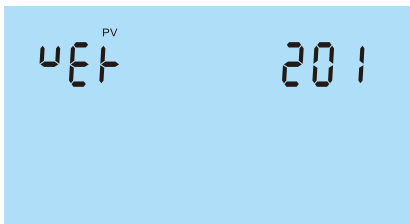
Rated VA / WATT Rated VA is 1KVA, WATT is 1KW 	Rated battery voltage / Max. charge current Rated battery voltage is 12V, Max charge current is 80A 
Firmware version Firmware version is 201 	Max PV Voltage / Max MPPT Current Max PV Voltage is 105V, Max MPPT Current is 60A 
Firmware version Firmware version is 201 	

Turbo mode

In order to avoid operation failure caused by charging overload protection, Turbo mode is automatically activated when the total output power exceeds the rated output power, so that the product can power high-power devices at the rated output power. When using Turbo mode, note the following:

- Turbo is enabled by default. To disable Turbo, you can set it in the Settings or APP.
- The Turbo mode is disabled in the following three scenarios
 - The mains is connected and in mains mode
 - The mains is set to UPS mode
 - When the Turbo mode is set to off
- Turbo mode is more suitable for heating and motor equipment, but not for all electrical appliances, some electrical appliances equipped with voltage protection (such as precision instruments, etc.) do not apply to Turbo mode. To confirm whether the device can use the Turbo mode, refer to the actual test.

Warning Code Table

When fault event happens, the fault LED is flashing. At the same time, warning code, icon  is shown on the LCD screen.

Warning Code	Warning Information	Audible Alarm	Trouble Shooting
03	PV charging overcurrent	Beep three times everysecond	Restart the unit, if the error happens again, please return to repair center.
04	PV temperature is too high		Check whether the air flow of the unit is blocked or whether the ambient temperature is too high.
05	High PV voltage		Please check the voltage of the solar panel, it should be less than 95V. If the voltage is ok, please contact your installer.
06	The PV relay voltage is abnormal		Internal components failed. Restart the unit, if the error happens again, please return to repair center.
07	PV relay short circuit		Check if the Fans wiring connected well. Replace the fan.
08	Fan 1 is locked.		
09	Fan 2 is locked.		
10	Overload	Beep twice every second	Reduce the loads.
11	Low battery	Beep three times everysecond	The battery voltage is too low, it should be charging.
16	The communication between the primary and secondary cpus is faulty		Internal components failed. Restart the unit, if the error happens again, please return to repair center.

Fault Code Table

When fault event happens, inverter will cut off output, and the fault LED is solid on. At the same time, fault code, icon  and **ERROR** are shown on the LCD screen.

07	Battery voltage is too high	Check if spec and quantity of batteries are meet requirements.
17	Overload protection	Reduce the loads and Restart the machine.
19	Output short circuit	Check if wiring is connected well and remove abnormal load.
21	OP current sensor failed	Restart the unit, if the error happens again, please return to repair center.

22	Output voltage is too low	Reduce the connected load. Restart the unit, if the error happens again, please return to repair center.
23	Output voltage is too high	Restart the unit, if the error happens again, please return to repair center.
24	Excessive inverter current	Reduce the connected load by switching off some equipment.
25	The inverter hardware current is too large	Reduce the connected load by switching off some equipment.
26	The soft start of the inverter voltage fails	Restart the unit, if the error happens again, please return to repair center.
29	The inverter current sensor is faulty	Please return to repair center.
30	Bus voltage is too low	Restart the unit, if the error happens again, please return to repair center.
31	Bus voltage is too high	AC Surge or internal components failed. Restart the unit, if the error happens again, please return to repair center.
33	Bus soft start fail	Internal components failed. Restart the unit, if the error happens again, please return to repair center.
34	Overtemperature occurs in radiator 1	Check whether the air flow of the unit is blocked or whether the ambient temperature is too high.
35	Overtemperature occurs in radiator 2	Check whether the air flow of the unit is blocked or whether the ambient temperature is too high.
50	EEPROM fault	Please return to repair center.
90	DSP BootLoad is not written	Please return to repair center.